

JShare

File Sharing Made Easy

Brian Schisler

Project Specialist
Enterprise Services
Information Technology @ Johns Hopkins

Daniel Bodami

Senior Systems Software Engineer
Enterprise Services
Information Technology @ Johns Hopkins

Planning for the future. Now.

INFORMATION TECHNOLOGY @ JOHNS HOPKINS

Overview of Discussion Topics

- Johns Hopkins At-A-Glance
- Communication & Collaboration
- File Sharing Made Easy
- JShare Implementation
- Technical Specifications
- User Success Stories
- Overall Impact
- Next Steps



Johns Hopkins Institutions



INFORMATION TECHNOLOGY @ JOHNS HOPKINS

Johns Hopkins At-A-Glance

■ Homewood Campus

- Krieger School of Arts & Sciences
- Whiting School of Engineering
- School of Professional Studies in Business & Education

■ East Baltimore

- School of Medicine
- School of Nursing
- Bloomberg School of Public Health

■ Nitze School of Advanced International Studies

■ The Peabody Institute

■ Applied Physics Laboratory

Johns Hopkins At-A-Glance

- Fairly Decentralized
- Approximately 30,000 users
- Faculty, Staff, Students & Alumni
- Approximately 2,200 Public Workstations and 8,500 Private Workstations
- Various Operating Systems

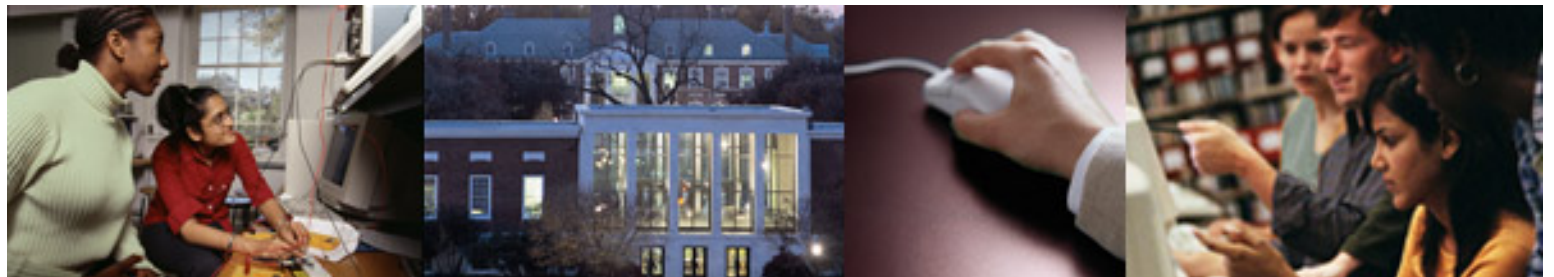

INFORMATION TECHNOLOGY @ JOHNS HOPKINS

Communication & Collaboration

- Two Major Enterprise Email Systems
- Email Attachment Size Restrictions
- Home Grown File Sharing Application-
FESTER
- Issues with FESTER
- Xythos Solution



File Sharing Made Easy

- Completely Web-Based
- Easy Learning Curve
- Multi-Platform Application
- File Sharing Opportunities both Inside and Outside of the Institution
- Secure File Access – SSL
- Personal Web Space



JShare Implementation

Summer 2004

Xythos WFS Installed and
Setup
Create Pilot Group
Testing Begins

Winter 2004/2005

Collect feedback from Pilot
Group
JShare documentation
created
JShare launched to various
groups around the
University and Hospital

Spring/Summer 2005

JShare is released to all of
Johns Hopkins users
JShare web site is launched
JShare is upgraded to Ver. 5
Online tutorials are added to
JShare documentation
Training & Demonstrations
conducted with various
divisions

Fall/Winter 2005

Testing began to integrate
JShare with new Johns
Hopkins Portal Project and
SiteMinder, a single sign on
solution

Johns Hopkins University JSHARE Service Design

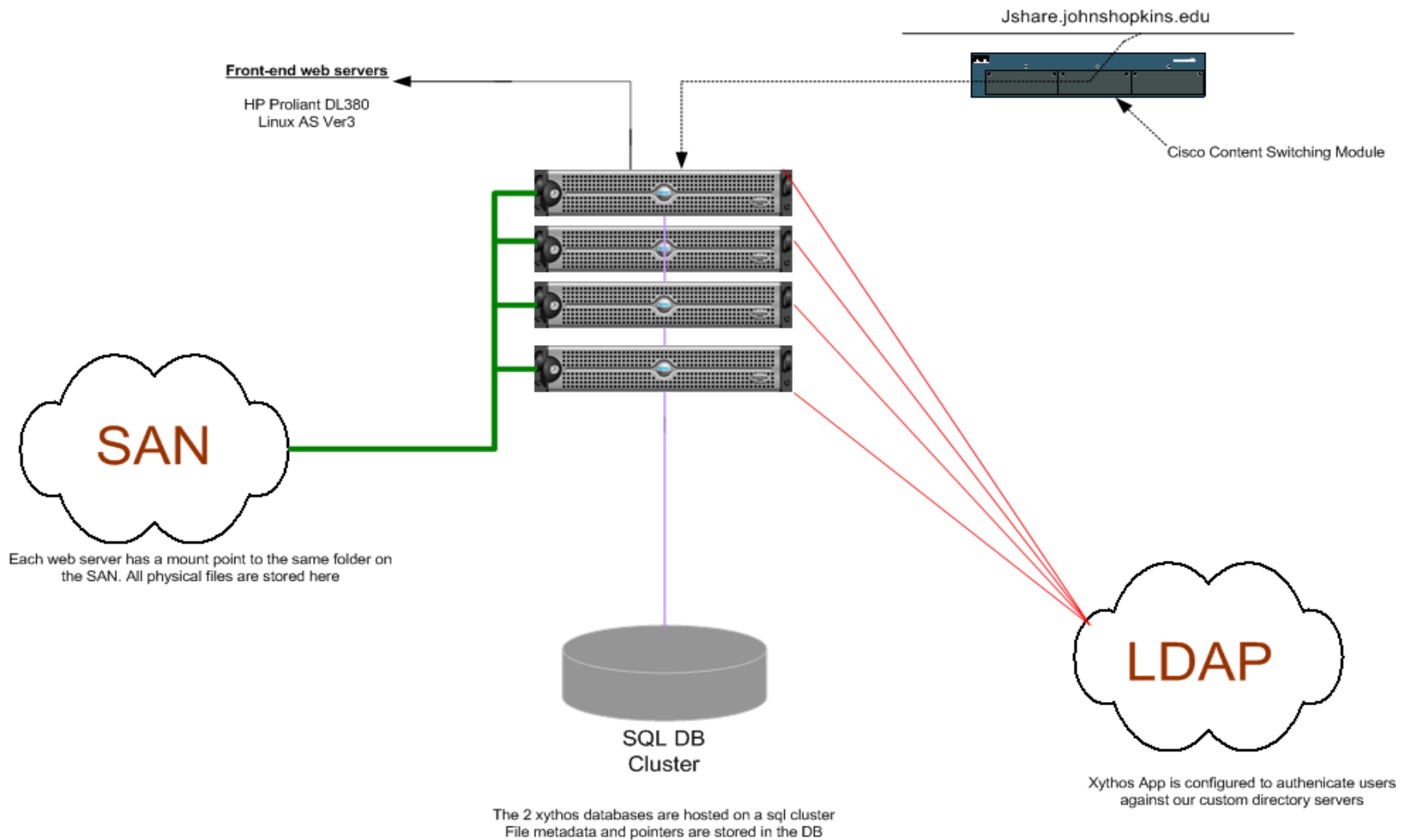

Getting Started

- Fully Integrated with JHED
- Automatic Account Creation
- User Acceptable Use Policy
- Default Account Setup
 - Public_HTML Folder
 - 100 megabytes for Students & Staff
 - 500 megabytes for Faculty

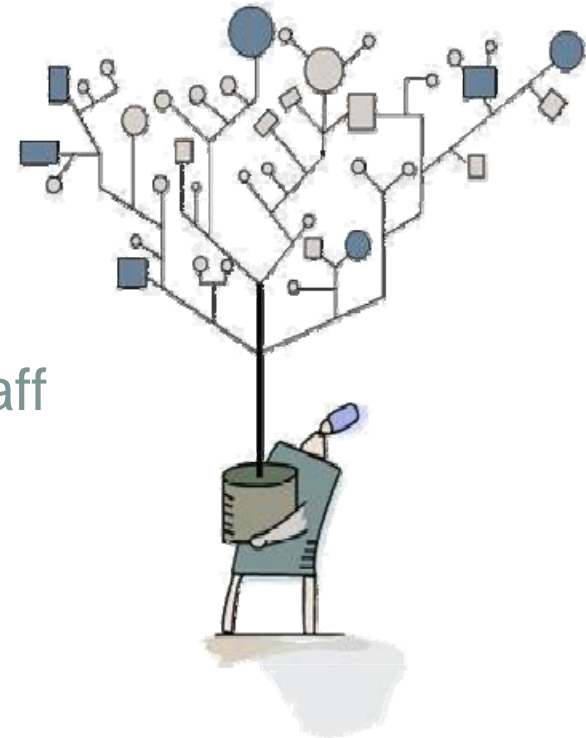

Users by Division

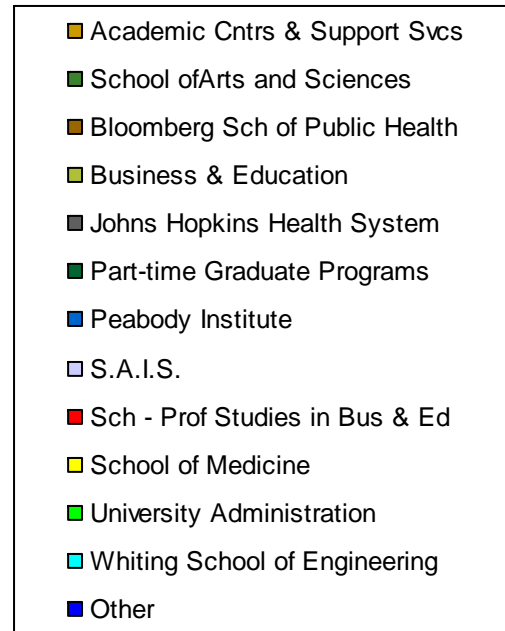
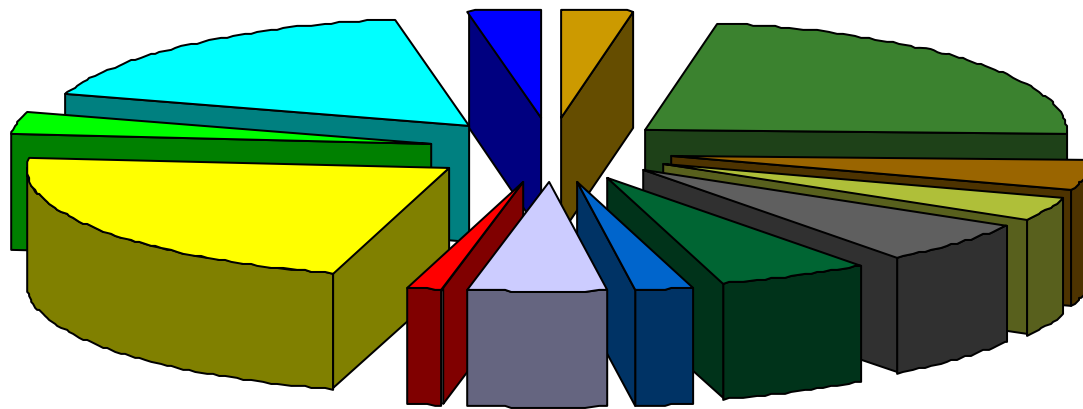

Monthly Storage Use

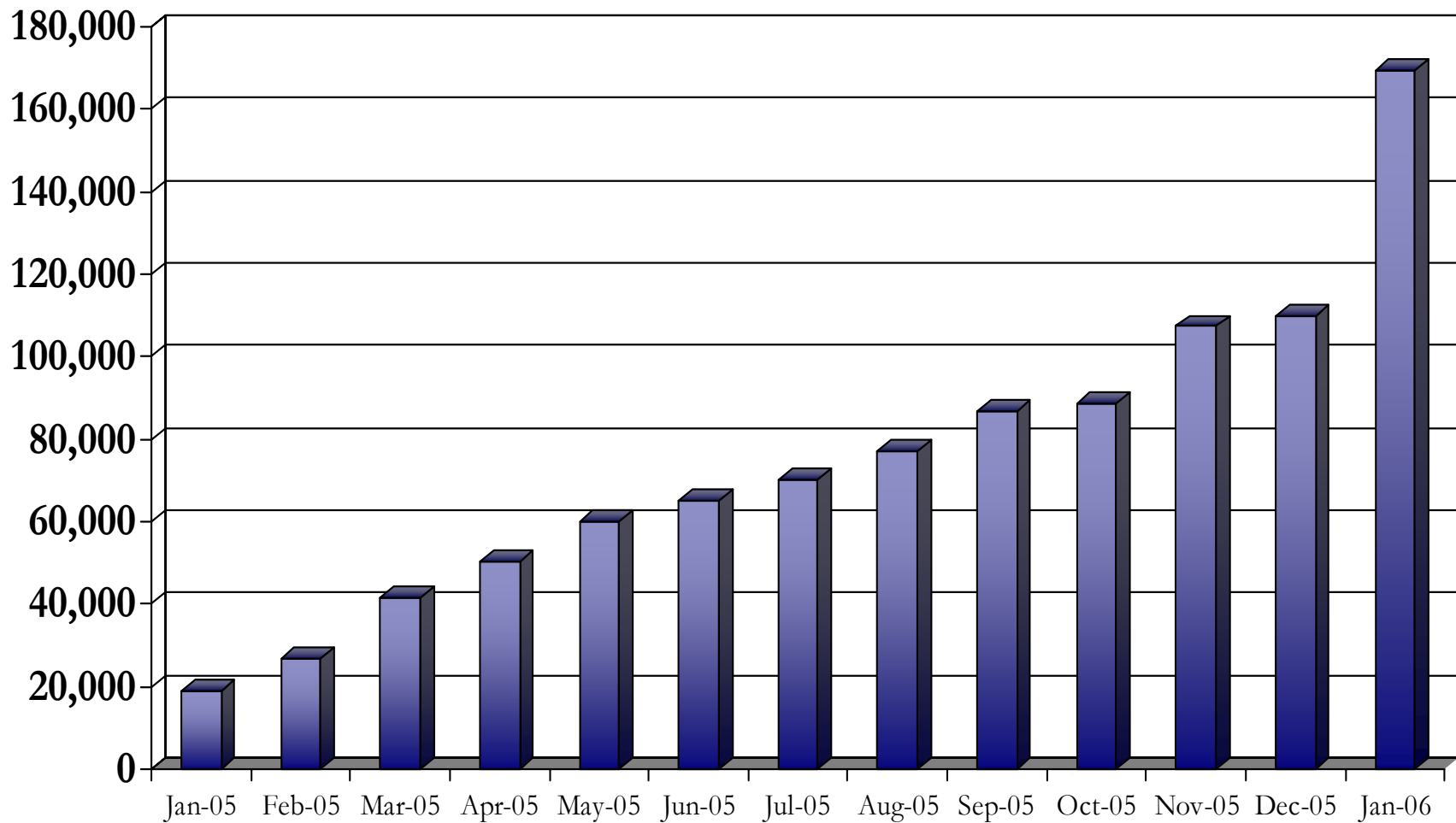

Using JShare

The screenshot displays the JShare web interface. On the left, the Johns Hopkins logo is visible, along with the user's login information: "Logged in as: BRIAN P SCHISLER" and a "Log out" button. Below this is a "Bookmarks" section with a list of links including "/bschis1", "Alliance", "Alliance Group", "EnterpriseWebServices", "ESGTEST", and "JHUGroups".

The main content area shows a directory listing for "/bschis1". At the top, there is a toolbar with icons for Up, Search, Web Folder, Refresh, New Directory, Upload, Move, Copy, Delete, Rename, Download, Email, and Help. Below the toolbar, the directory path is shown as "/bschis1".

<input type="checkbox"/>	Name	Manage	Share	Lock	Delete	Modified	Size
<input type="checkbox"/>	Personal					12/7/05	96KB
<input type="checkbox"/>	SCC					11/17/05	11.3MB
<input type="checkbox"/>	Xythos Documentation					6/29/05	11.9MB
<input type="checkbox"/>	1202.pdf ?					10/11/05	60.9KB
<input type="checkbox"/>	tour.ppt ?					12/1/05	689.5KB
<input type="checkbox"/>	5 items						Total size: 15.8KB (Quota: 750MB, Available: 750.0MB)

Personal Web Space

- Create static HTML web sites

[https://jshare.johnshopkins.edu/\[JHED_ID\]/directoryname](https://jshare.johnshopkins.edu/[JHED_ID]/directoryname)

- Access Control Options

- Users with Accounts

- Public

- Specific User/Group

- Multiple File Uploads – Web Folders

- WebDav- Xythos Drive

Web Folders

bschis1 on jshare.johnshopkins.edu - Microsoft Internet Explorer

Up Search Web Folder Refresh New Directory Upload Move Copy Delete Rename Download

Directory: /bschis1

<input type="checkbox"/>	Name	Manage	Share	Lock	Delete	Modified
<input type="checkbox"/>	Personal					12/11/06
<input type="checkbox"/>	SCC					11/11/06
<input type="checkbox"/>	Xythos Documentation					6/11/06
<input type="checkbox"/>	1202.pdf					10/11/06
<input type="checkbox"/>	tour.ppt					12/11/06

5 items Total size: 15.8KB

Pediatric Residents

- Approximately 81 Residents
- Individual Accounts & Group Account
- Maintain Schedules, Contact Information and Policy Statements
- Granted Access to Emergency Medicine
- Inpatient Sign-Out

Grant Applications

“JShare is not a panacea, because people can always use good tools badly, but with some consistent reminding, I’m able to reduce the number of duplicates that we have, and keep us better focused on our work product. The biggest advantage is that email is taken out of the mix...we don’t have multiple copies of our product clogging and confusing the process.”

G. Steven Bova, M.D.

*Assistant Professor of Pathology, Oncology, and Urology
Joint Appointment in Health Sciences Informatics*

Technology Opportunities Program



- Facilitates Industrial Acquisition of Johns Hopkins Intellectual Property
- Johns Hopkins Medicine Alliance for Science and Technology Development
- Biomedical Industries

Technology Opportunities Program

ABOUT JOHNS HOPKINS MEDICINE | HEALTH INFORMATION | PATIENT CARE | RESEARCH | EDUCATION | < HOME

TECHNOLOGY OPPORTUNITIES PROGRAM (TOP)

You are not logged in. You must log in to view this resource.

INFORMATION:

- Projects
- Membership
- Meetings
- Johns Hopkins Technology Transfer (JHTT)
 - JHTT Search
- Applied Physics Laboratory (APL)
 - APL Search
- Sample Agreements
- For ALLIANCE Members
- For TOP Members
- Join TOP Now

You are logged in as BRIAN P SCHISLER but may not view this resource.

[\[Log out\]](#)

[Thomas Beck, Sc.D.](#) | [Method for Measuring Bone Strength \(presentation PowerPoint\)](#)

[David Block, M.D., M.B.A.](#) | [Update on Progress and](#)

Overall Impact

- Improved Business Processes
- Improved Communication and Collaboration Opportunities



Next Steps

- Integrate JShare with SiteMinder and the Johns Hopkins Portal for single sign-on
- Evaluate new opportunities to use JShare around the Institution
- Explore new ways to improve the user experience

Questions or Comments 

For More Information

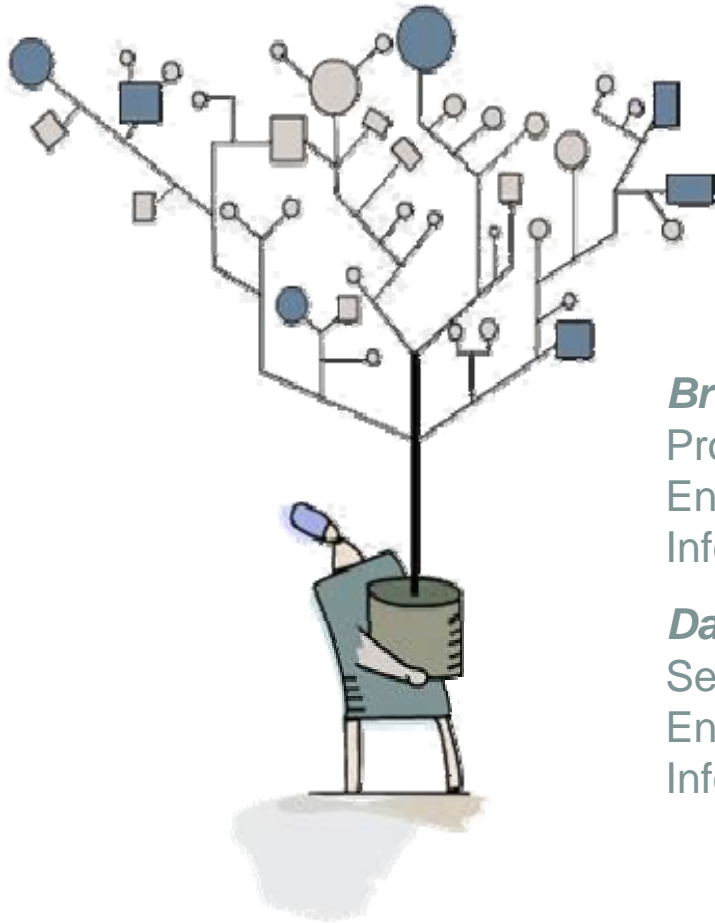

Visit our Web Site at
www.it.jhu.edu/jshare

Brian Schisler

Project Specialist
Enterprise Services
Information Technology @ Johns Hopkins

Daniel Bodami

Senior Systems Software Engineer
Enterprise Services
Information Technology @ Johns Hopkins